

Oct 2004

ALSTOM

Radiative & Thermal Modelling

Julian Thomas

ALSTOM

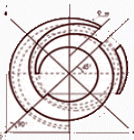

Contents

ALSTOM

- Review of Analysis Case concept

- Step by step:
 - Statement of problem
 - Layout of model
 - Radiative Cases
 - Analysis Cases

- Analysis Case Control -

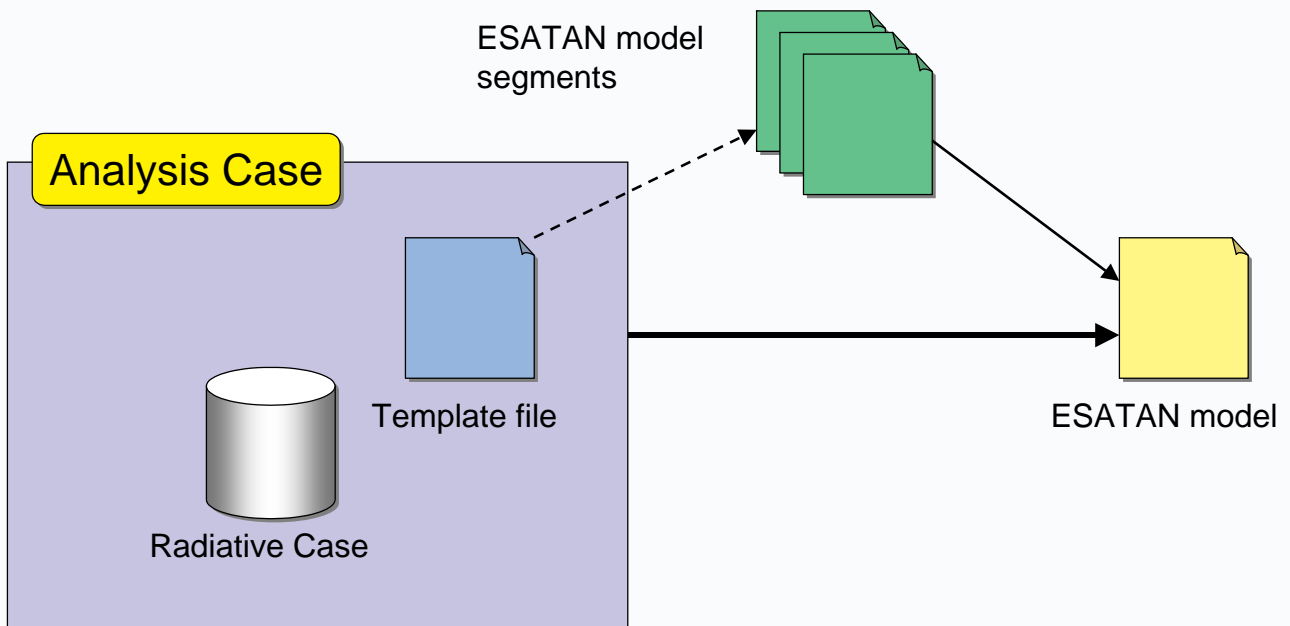
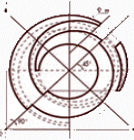

- Control & Manage Multiple Cases -

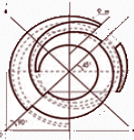

Interactive Demo

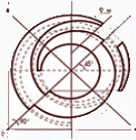

Our Example "Problem"

ALSTOM

GEO Sat

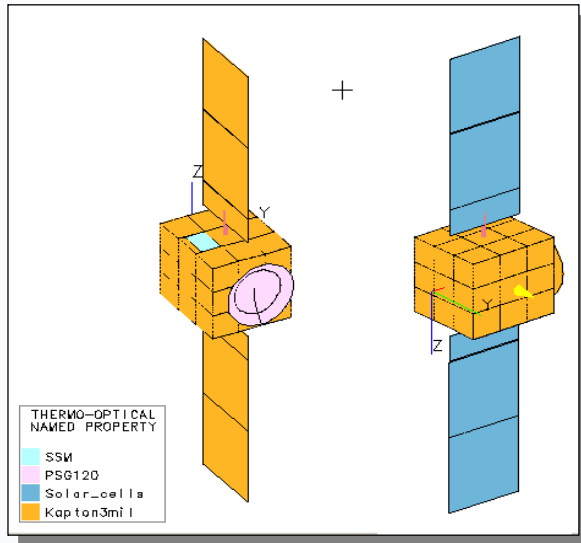

- 3 analysis conditions (cases) to consider:
 - Summer BOL Operating
 - Summer BOL Non-Op
 - Winter EOL Operating
- Unit mounted internally on the north panel, with an external radiator surface.

- External Geometry -

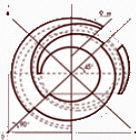

Our Example "Problem"

ALSTOM

GEO Sat

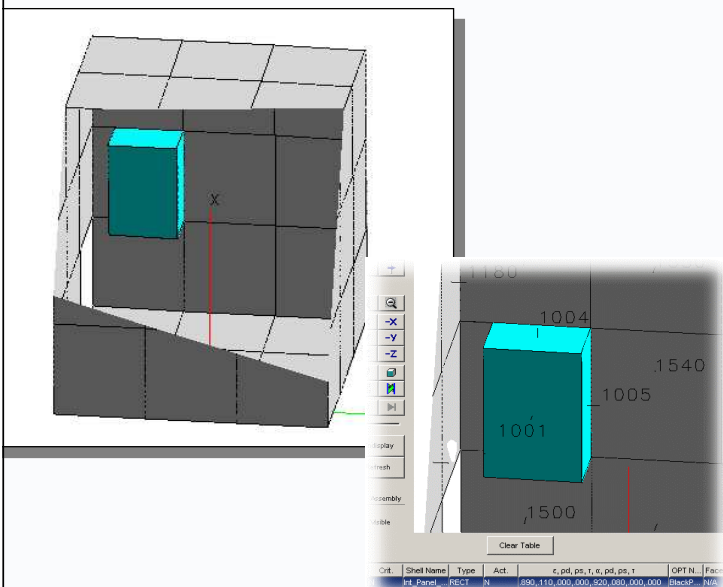

- 3 analysis conditions (cases) to consider:
 - Summer BOL Operating
 - Summer BOL Non-Op
 - Winter EOL Operating
- Unit mounted internally on the north panel, with an external radiator surface.

- Internal Geometry -

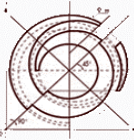

Our Example "Problem"



GEO Sat

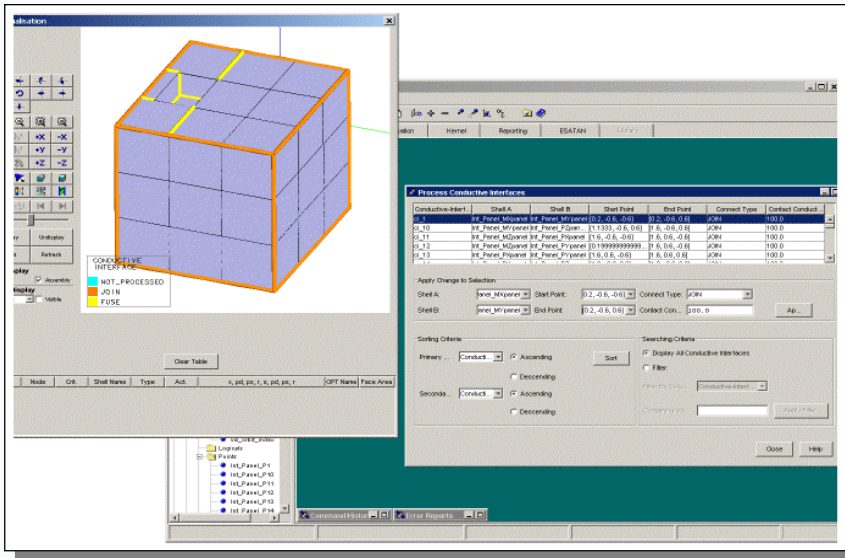

- ACG used to find and calculate links.
- New general ACG solver to be released in 2005.

- Conductor Generation -

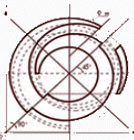

Radiative Cases

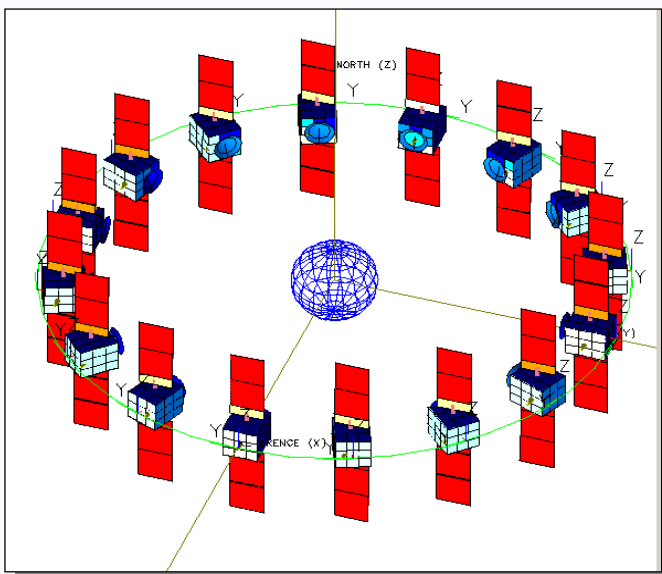

- Need to consider 2 Radiative Cases:
 - Summer BOL
 - Winter EOL
- Vary:
 - Earth-Sun distance
 - Solar Declination
 - Optical Properties

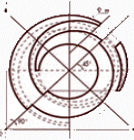

Optical Property Environment

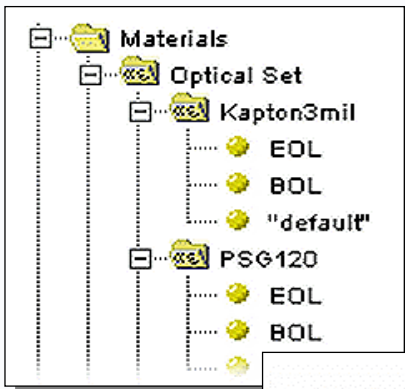

Selected in Radiative Case:

initial angular offset:

Property Environment

Property Environment

- Introduced with v5.6 -

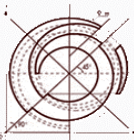

Case Management



Analysis Cases	Template file	Radiative Cases	ESATAN segments	ESATAN models
Winter EOL Op		Winter EOL	Non-Geom Nodes & Conductors, etc.	Unit /heater Power
Summer BOL Op				
Summer BOL NonOp		Summer BOL		

- Control & Manage Multiple Cases -

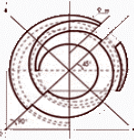

File Organisation

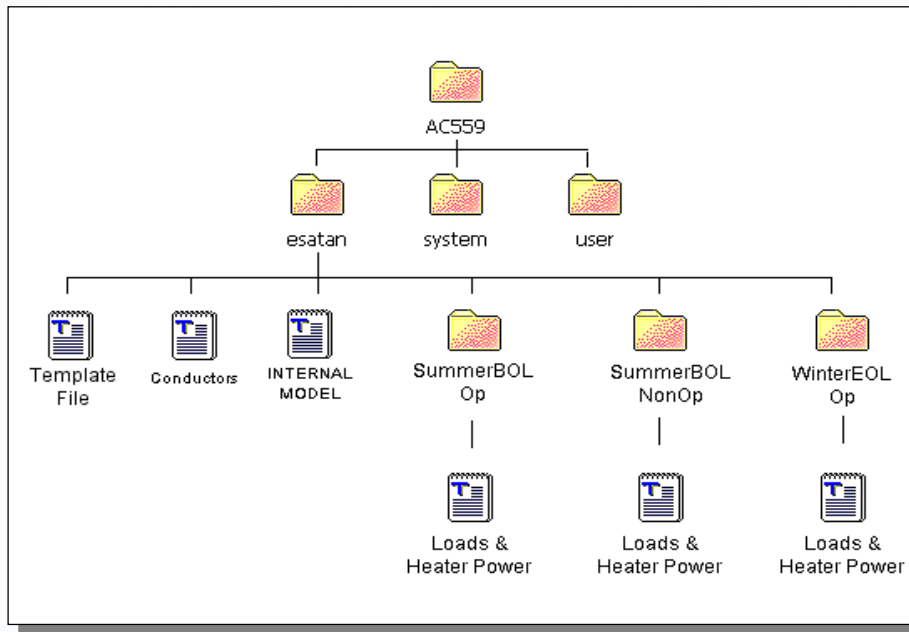

Demo



Interactive Demo

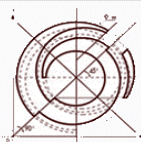

And the Results...

ALSTOM

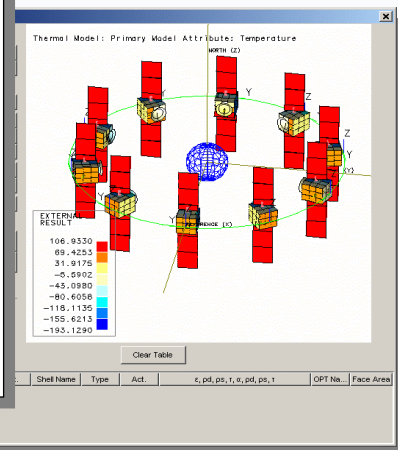
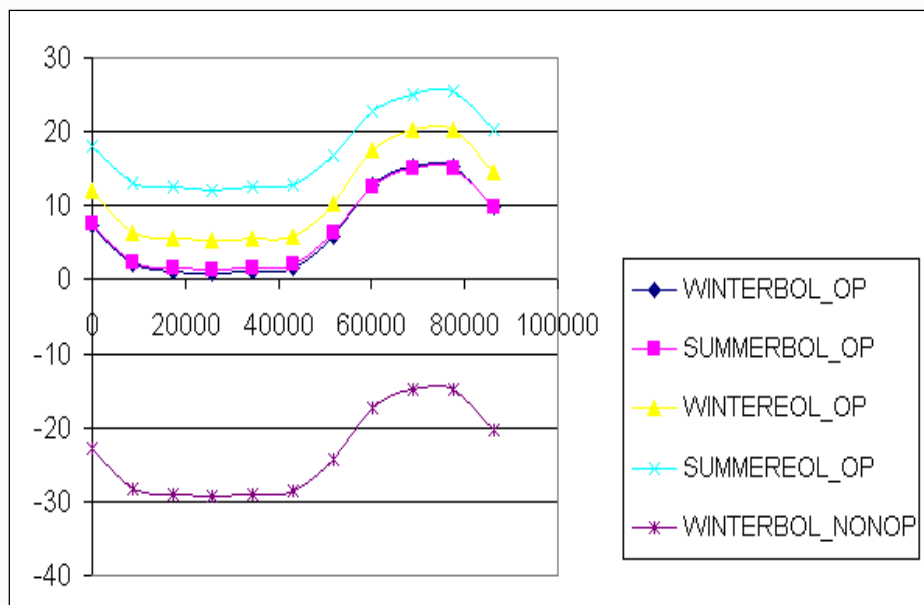

ALSTOM

www.alstom.com